

Donkey

Version 1.2

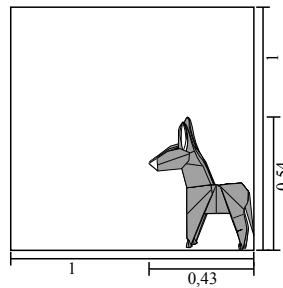

Recommended paper size: 25 x 25 cm

Model: Daniel Chang, April 2010
Diagram: Daniel Chang, Mars 2011

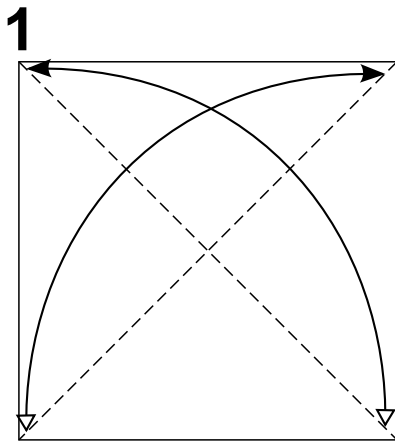

1
Fold along the diagonals and unfold again.

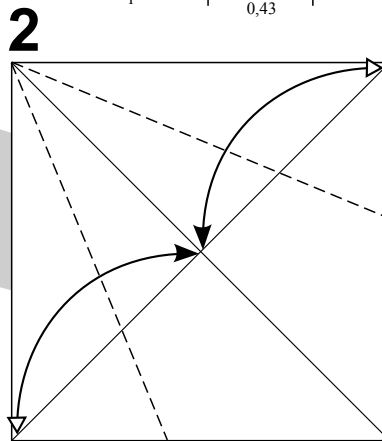

2
Fold the edge towards the diagonal line and unfold again.

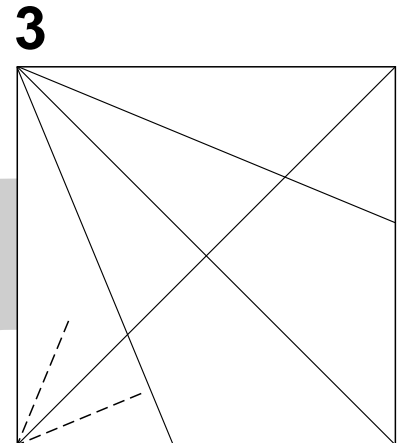

3
Crease the edge partly towards the diagonal line and unfold again.

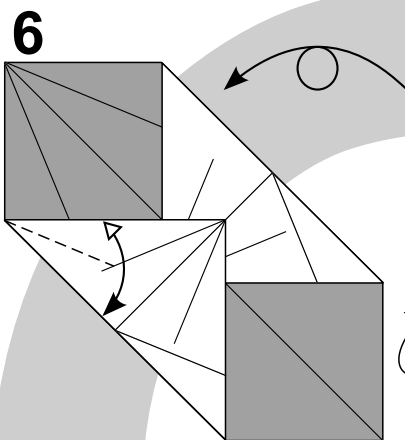

6
Fold the edge down and unfold.

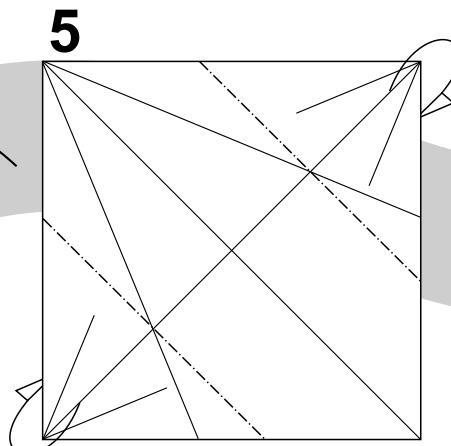

5
Mountain-fold the corners and turn the paper around.

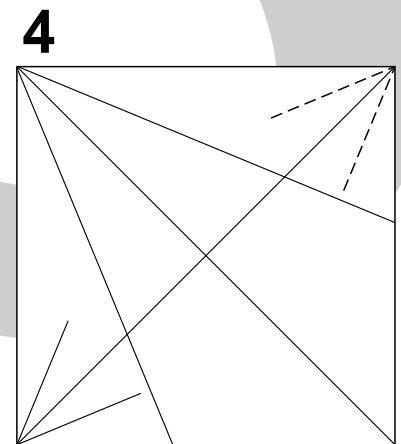

4
Repeat step 3 on the opposite side.

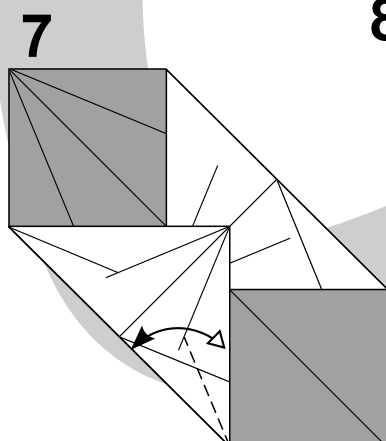

7
Repeat the step on the lower side.

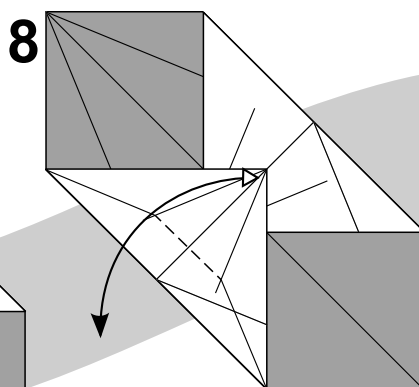

8
Mountain-fold the tip and unfold.

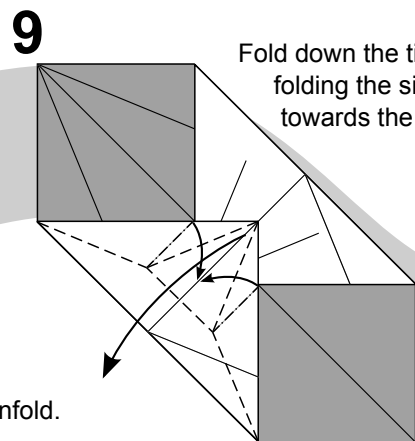

9
Fold down the tip while folding the sidelines towards the center.

12

Inside reverse fold the sides.

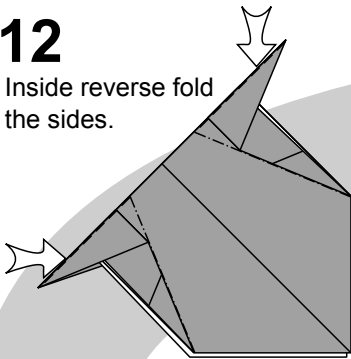

11

Mountain-fold the tip.

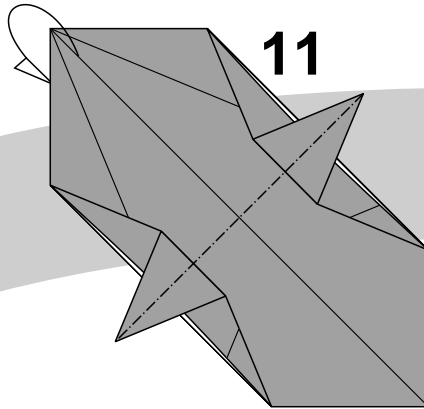

10

Repeat the step on the opposite side.

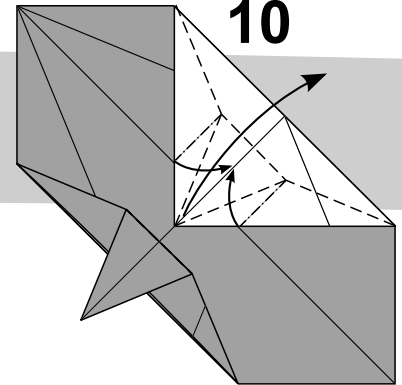

13

Valley-fold the tip upwards.

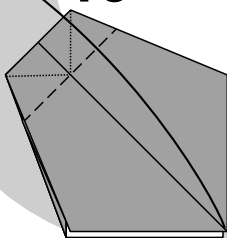

14

Mountain-fold.

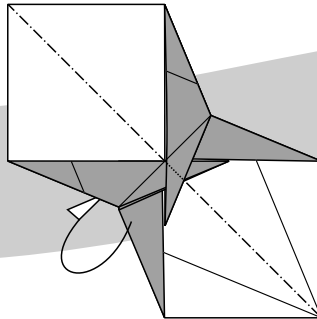

15

Inside reverse fold the lower tip upwards.

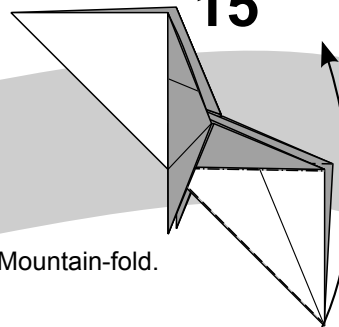

16

Inside reverse fold the lower tip downwards.

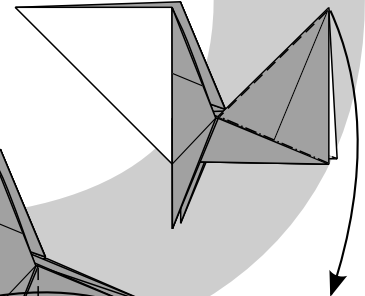

19

Valley-fold the lower side towards the upper side.

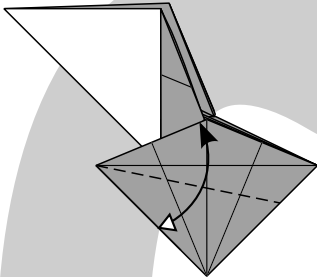

18

Fold the tip upwards and unfold.

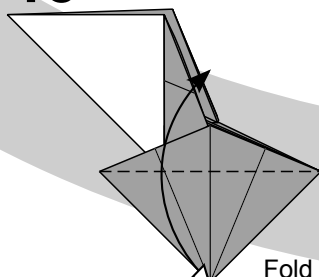

17

Fold the corner to the left.

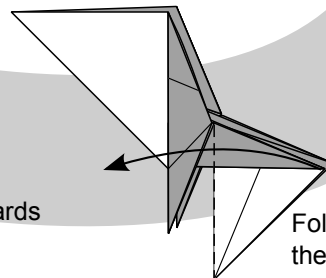

20

Repeat the step on the other side.

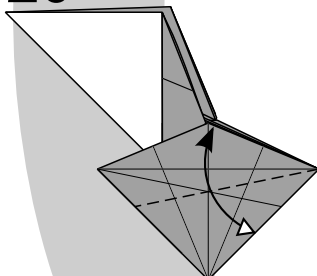

21

Fold up the tip.

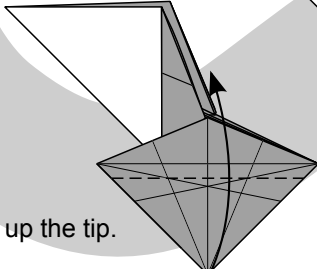

22

Fold up the corners and unfold.

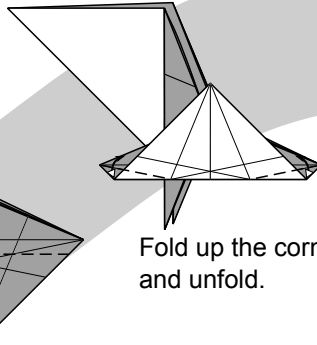

23

Fold down the tip on the existing crease.

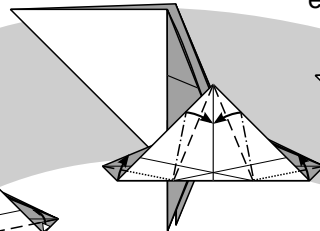

24

Fold up the corners and fold the sidelines towards the center.

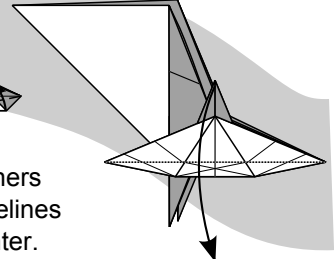

27

Mountain-fold the right hind leg.

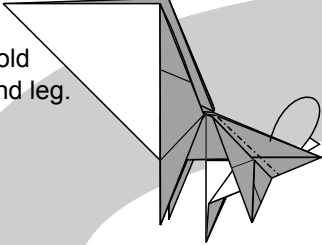

26

Mountain-fold.

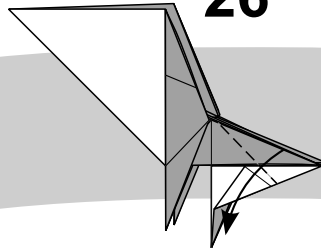

25

Fold the tip to the right.

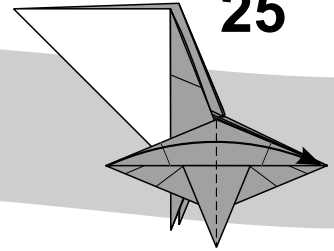

28

Fold the tail tip upwards.

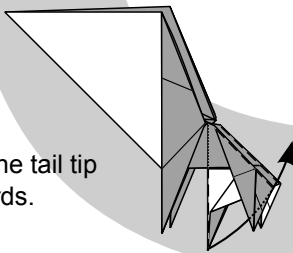

29

Squash the tail down while opening it to the left.

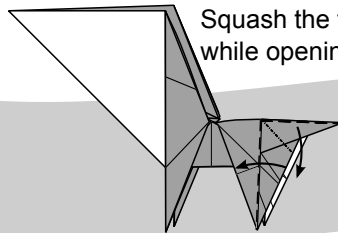

30

Inside reverse fold the sides.

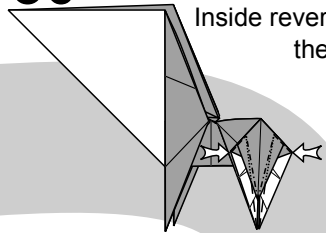

33

Inside reverse fold the inner and outer layer to the right.

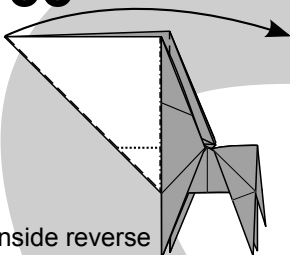

32

Also hide the right side.

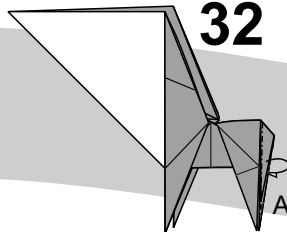

31

Hide the left part of the tail inside the pocket of the hind leg.

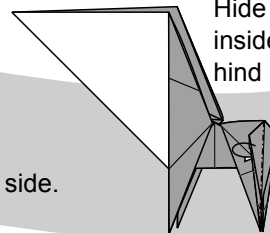

34

Inside reverse fold to the left.

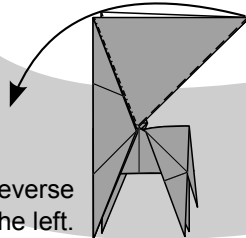

35

Inside reverse fold.

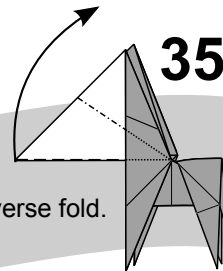

36

Inside reverse fold the front part.

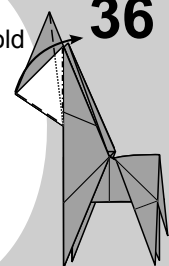

39

Fold down both tips.

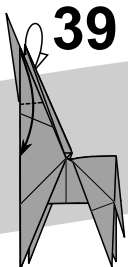

38

Repeat step 36 to 37 on the other side.

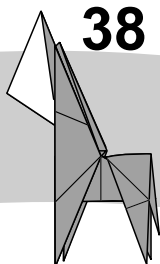

37

Inside reverse fold to the left.

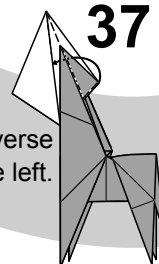

40

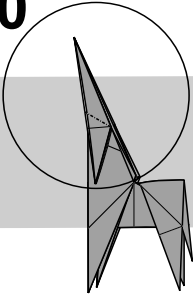

Zoom in on the head.

41

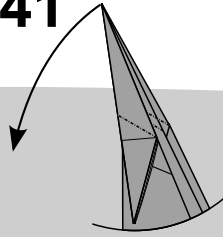

Reverse fold the tip to the left.

42

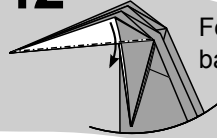

Fold down the front and the back layer of the head.

43

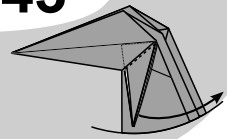

Pull out the tips to the right.

44

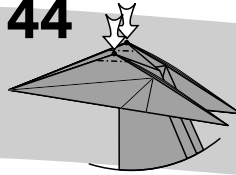

Open sink the two corners of the head.

45

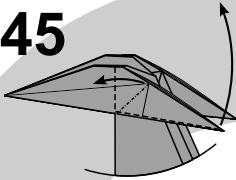

Squash the left ear upwards and open it to the left.

48

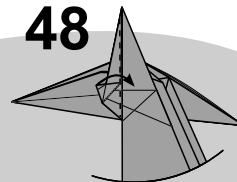

Fold back the left part.

46

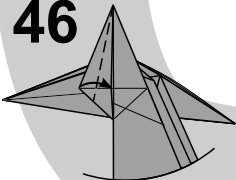

Valley-fold to the right.

47

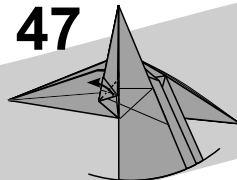

Open up the pocket and flatten it.

49

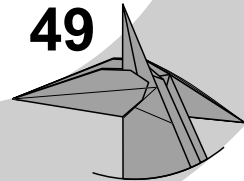

Repeat step 45 to 48 on the right ear.

51

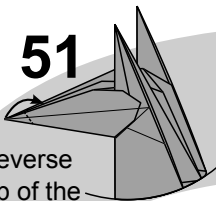

Outside reverse fold the tip of the mouth.

50

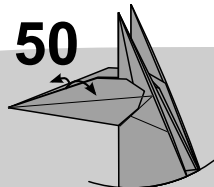

Pull apart the two head sides to make it three-dimensional.

52

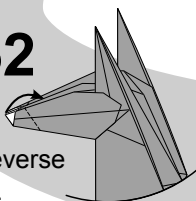

Outside reverse fold again.

53

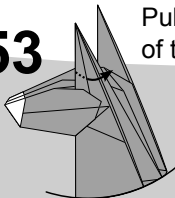

Pull out the hidden layers of the ear and shape them.

54

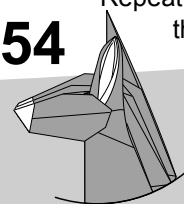

Repeat step 53 on the right ear

